

PREP **4** YOU



*Fresh & healthy
preparations made easy*



Combined machines



PREP 4 YOU

*Fresh & healthy
preparations made easy*

COMBINED MACHINES



*Maximum flexibility:
convert from slicer to cutter
and reverse, in few seconds!*



Consistent cutting results and maximized load capacity (1,25 lt.) thanks to the patented lever-pusher*



Large output chute for efficient ejection. Suitable for GN containers **up to 200 mm** high



Bowl and lid scraper for **uniform results** and **continuous working**

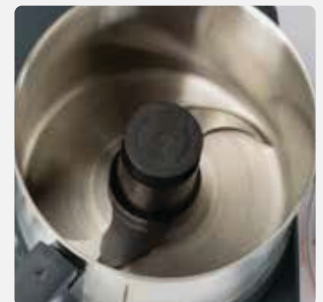

All ingredients are processed evenly and quickly thanks to the special flow generated inside the bowl

* Lever pusher applied for Patent EP19165854 and related family



















Wide range of discs

Slice, dice, grate, shred with a variety of 22 optional disks and grids in different sizes.
Outstanding results even when dicing difficult vegetables such as **tomatoes** and **onions**



Save up to 95% of your time without manual preparations

							
	Tomato	Cucumber	Celery root	Onion	Cabbage	Pizza cheese	Carrot
 Disk	10x10x10 mm dicing	2 mm slicing	4 mm shredding	8x8x8 mm dicing	1 mm slicing	7 mm grating	3 mm grating
 Amount	2 kg	2kg	3 kg	5kg	3 kg	5kg	3 kg
 Manual time	10' 37" 	6' 45" 	26' 05" 	37' 58" 	15' 06" 	34' 31" 	37' 04" 
PREP4YOU time	26"	1' 19"	1' 27"	1' 39"	2' 34"	2' 45"	3' 37"

PREP4YOU

*Fresh & healthy
preparations made easy*



Moon hopper 1,25 lt
capacity



Small hopper
Ø 55mm



Extra small hopper
Ø 25mm



100% dishwasher safe for best hygiene.
All parts in contact with food are easy to
remove for fast cleaning

**Scan the QR code on
appliance backside to
access user manuals,
videos and other
support materials**



Made in France, where we have over
75 years of experience designing and
producing high quality food preparation
equipment.

All parts in contact with food are
BPA free for best food contact safety



Your best choice for chopping, mixing and emulsifying



Smooth blade rotor
available as optional,
for clean cuts (for
example meat tartare)
and for delicate items
like fresh herbs



Micro-toothed blade rotor (included as
standard) for chopping,
grinding, mixing and
emulsifying



2.6 lt bowl
Transparent
copolyester



2.6 lt bowl
AISI304
stainless steel



3.6 lt bowl
AISI304
stainless steel

Discover the various preparations you can do with **PREP 4 YOU**

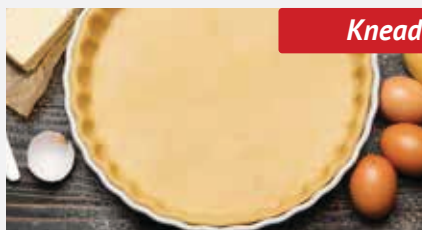

PREP 4 YOU

*Fresh & healthy
preparations made easy*

*Do you know how flexible your
PREP 4 YOU is?*

Vegetable slicer and cutter mixer, small and does it all!
Slice, dice, grate, chop, mix, grind and emulsify quickly and easily



Health care facilities



Restaurants



Kindergarden & schools



Gastronomy / Take away



Speed up your preparations



Obtain **uniform results consistently**



Optimize on food quality and costs using **fresh products**



Chop herbs and mirepoix for tasty recipes



Prepare extra smooth **texture modified food**



Make your **salads fresh** and **appetizing** everyday



Mince meat, fish and vegetables for **tasty fillings** in record time



Perfectly cut **homemade fries**



Give a special twist to your **sandwiches** with crunchy salad, juicy tomatoes and tasty onions

Choose the right PREP⁴YOU combined machine

Vegetable slicer / Cutter mixer

Available in two versions:

Single speed with on/pulse/off function for simple operations

Variable speed for maximum flexibility:

- **5 levels vegetable slicer** adapting speed for high quality cuts
- **9 levels cutter mixer** for extra smooth results and emulsifying

Durable and reliable **industrial induction motor** for long life and silent operations. Asynchronous, direct drive motor, for extra power without need for maintenance



Combined model with 2,6 lt bowl

Speed	Phases	Power	rpm	Net weight
1 speed	1 ph	500 W	1500	15,8 kg*
Variable	1 ph	750W	500-3600	16.9 kg*

External dimensions (wxdxh): 348x328x527mm

* stainless steel bowl

Combined model with 3,6 lt bowl

Speed	Phases	Power	rpm	Net weight
1 speed	1 ph	500 W	1500	16.1 kg*
Variable	1 ph	750W	500-3600	17.2 kg*

External dimensions (wxdxh): 348x334x527mm

Vegetable Slicer
front/side

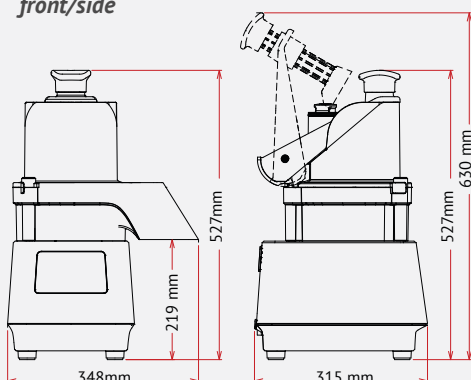

Cutter Mixer 2,6 lt bowl
front/side

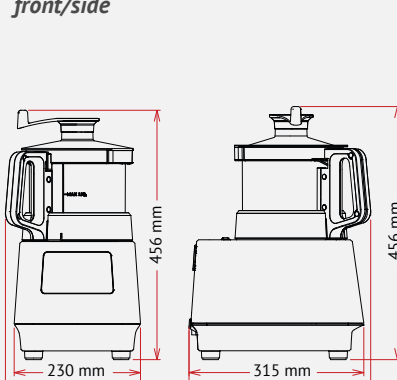

Cutter Mixer 3,6 lt bowl
front/side

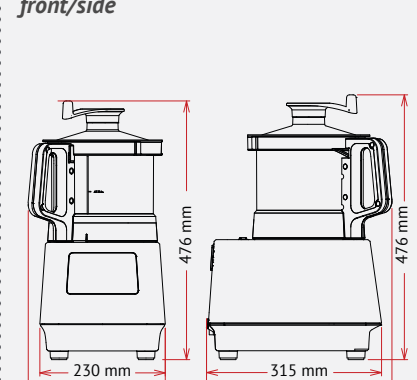



PREP4YOU

VEGETABLE SLICER | CUTTER MIXER | COMBINED MACHINES

